

**SERIES 47D**  
Sealed Sub-Miniature Rocker Switches

**FEATURES**

- Save Space and Weight
- SPDT and DPDT Circuitry
- Choice of Actuators and Terminations
- Sealed per IP-67

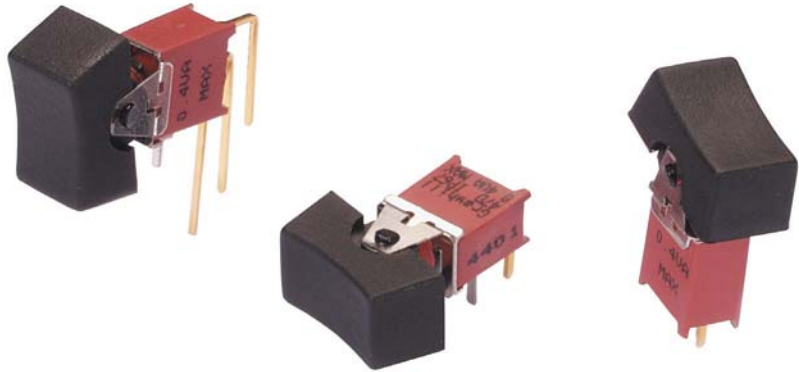

**MODELS** In inches (and millimeters)

**SPDT**

MODEL NO.	SWITCH POSITION		
WMSP1	ON	NONE	ON
WMSP2	ON	NONE	(ON)
WMSP3	ON	OFF	ON
WMSP4	(ON)	OFF	(ON)
WMSP5	ON	OFF	(ON)
TERM. COMM.	2-3	OPEN	2-1

(O)=MOMENTARY

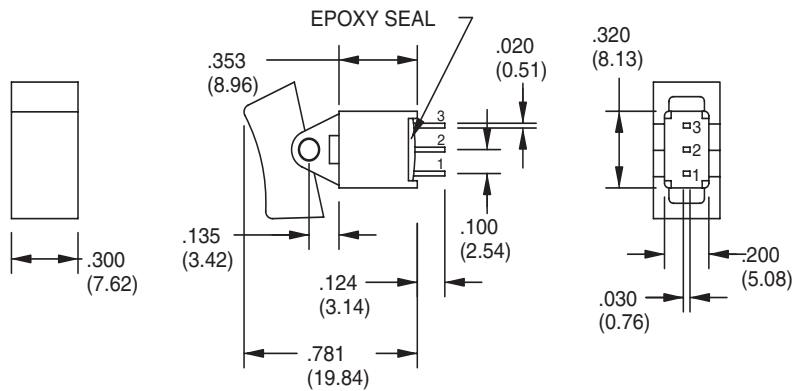

**DPDT**

MODEL NO.	SWITCH POSITION		
WMDP1	ON	NONE	ON
WMDP2	ON	NONE	(ON)
WMDP3	ON	OFF	ON
WMDP4	(ON)	OFF	(ON)
WMDP5	ON	OFF	(ON)
TERM. COMM.	2-3,5-6	OPEN	2-1,5-4

(O)=MOMENTARY

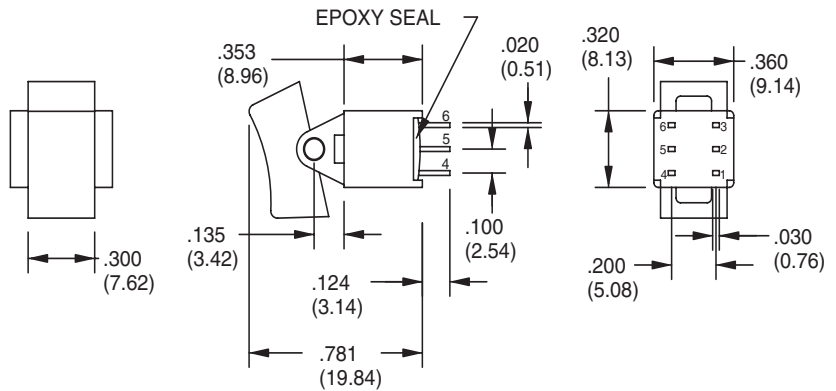
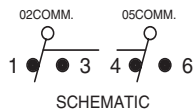

**ACTUATOR OPTIONS** In inches (and millimeters)

**R1**

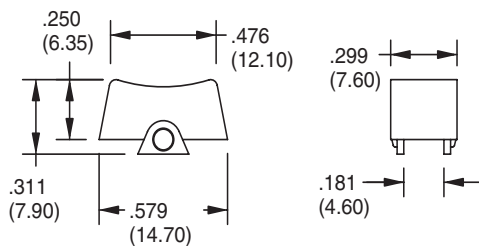

**R2**

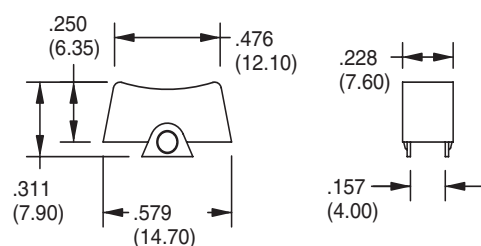

**TERMINATION OPTIONS** In inches (and millimeters)

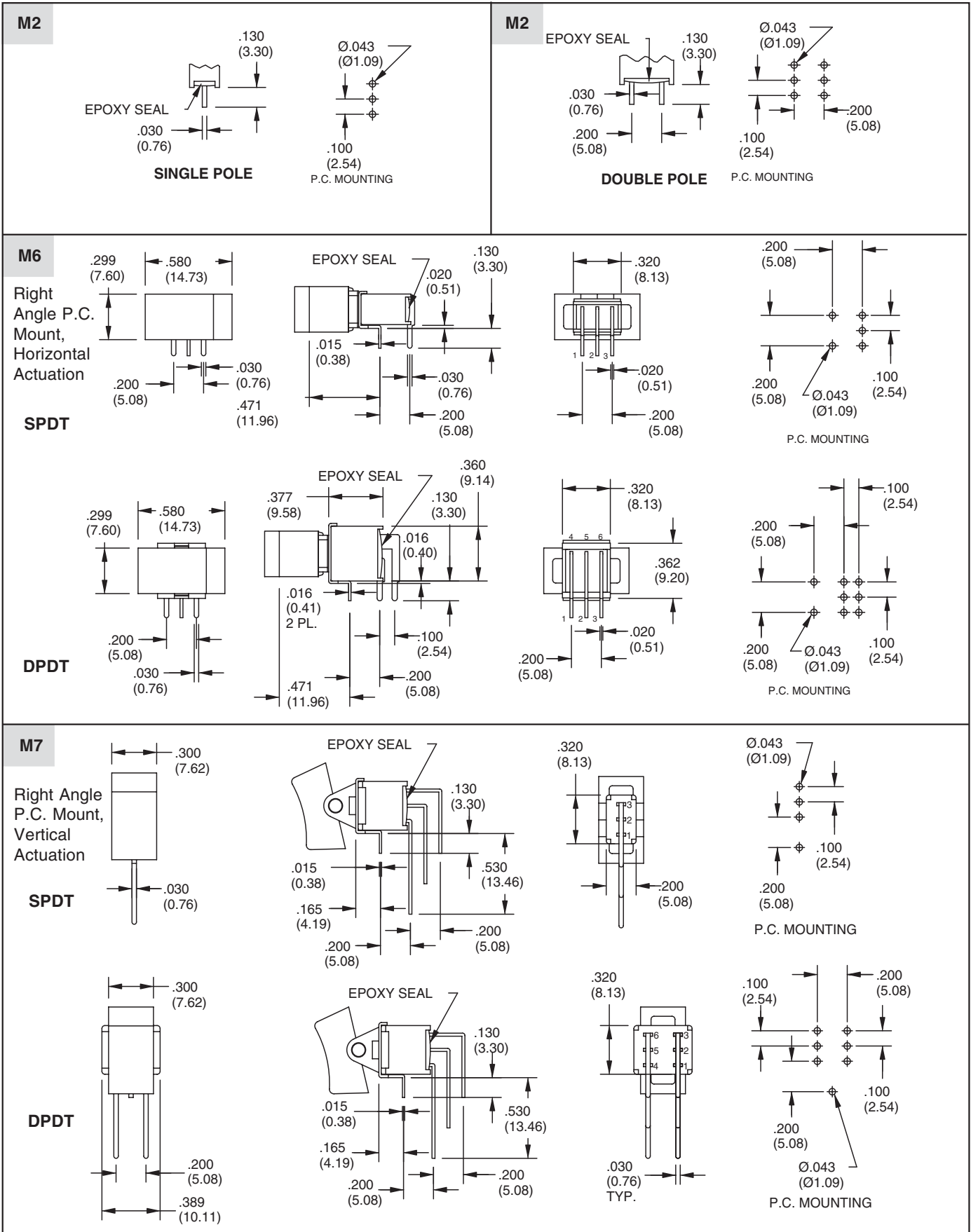

Rocker and Paddle Switches

**TERMINATION OPTIONS** In inches (and millimeters)

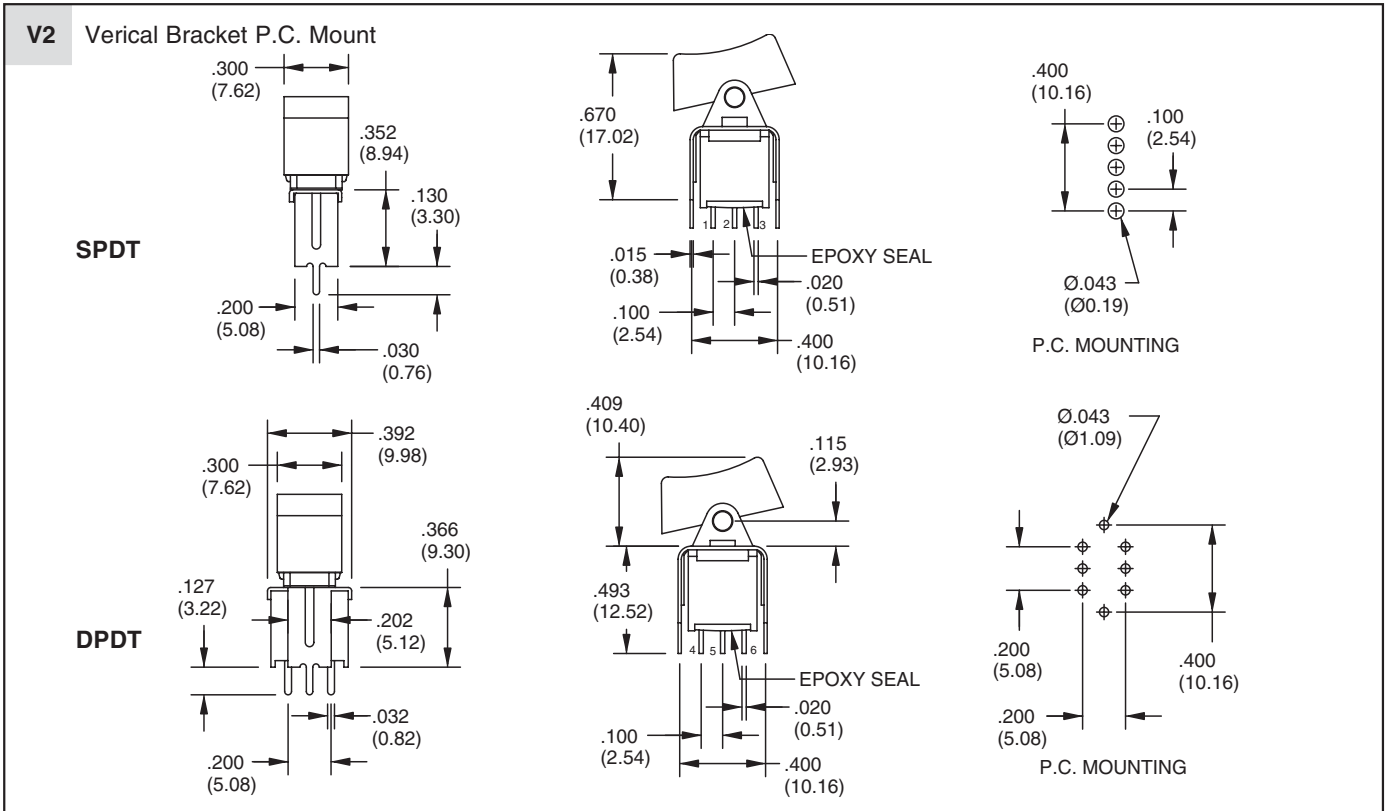

**SPECIFICATIONS**

**RATINGS**

**Contact Rating:** Q option - 3A with resistive load @ 125 VAC or 28 VDC; 1.5A with resistive load @ 250 VAC. R option - 0.4 VA max @ 20 Vmax (AC or DC)

**Electrical Life:** 30,000 make-and-break cycles at full load

**Contact Resistance:** 20 milliohms max. initial @ 2-4 VDC, 100 mA

**Insulation Resistance:** 1,000 megaohms minimum

**Dielectric Resistance:** 1,500 V RMS @ sea level

**Operating Temperature:** -30°C to 85°C

**MATERIALS**

**Case and Bushings:** Glass-filled nylon 6/6, flame retardant, heat stabilized (UL94V-0)

**Actuator:** Nylon, black standard. Internal o-ring seal standard with all actuators.

**Switch Support:** Brass, tin-plated

**Terminal Seal:** Epoxy

**Terminal/Contacts:** Copper alloy with gold plate or silver plate over nickel

**ORDERING INFORMATION**

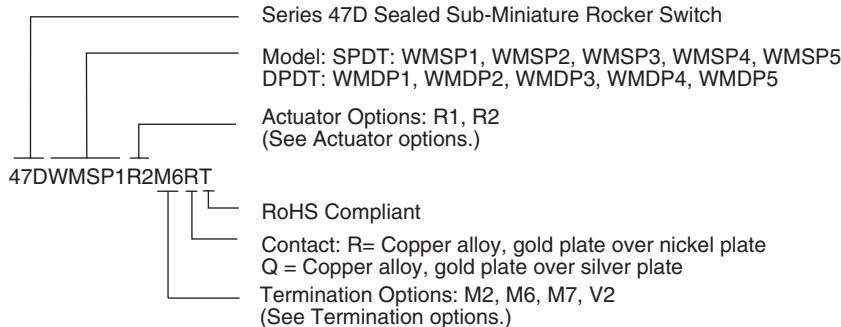

Available from your local Grayhill Component Distributor. For prices and discounts, contact a local Sales Office, an authorized local Distributor or Grayhill.